



Arama & Benet

Air Engineering Solutions

info@arama-benet.com
www.arama-benet.com

PRODUCT NAME:
TDF-A-R3 Series Single Inlet
Backward Curved Centrifugal Fan

PRODUCT TYPE:
TDFA 400-R3-0.75kW-4

Weight include motor:
77 kg

Finish: Painted
Color: RAL 7024

Arama & Benet

www.arama-benet.com

REV 02 04.2024

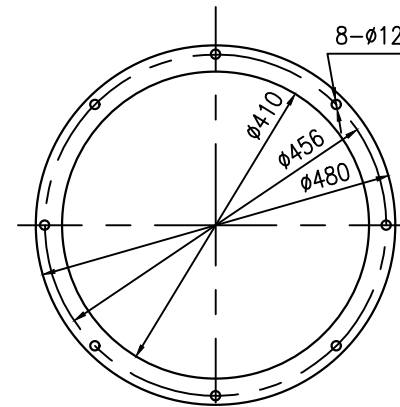
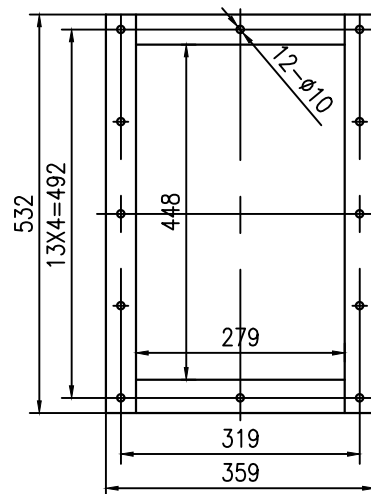
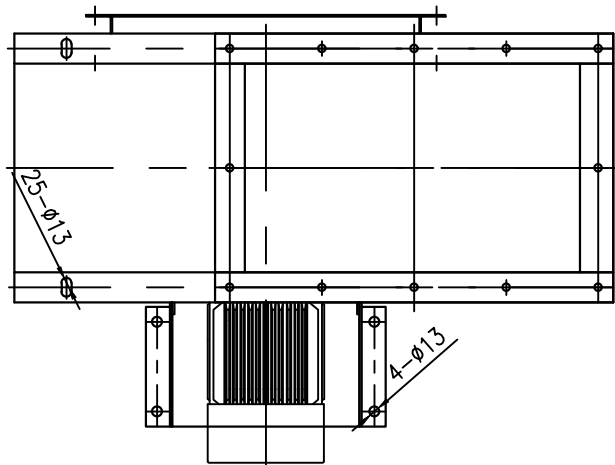
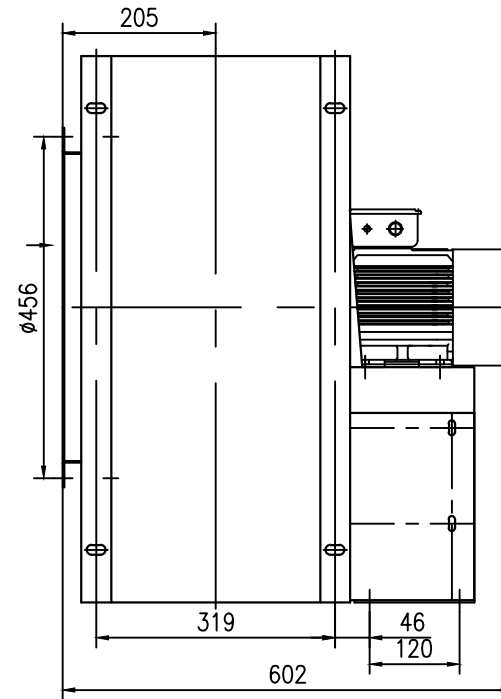
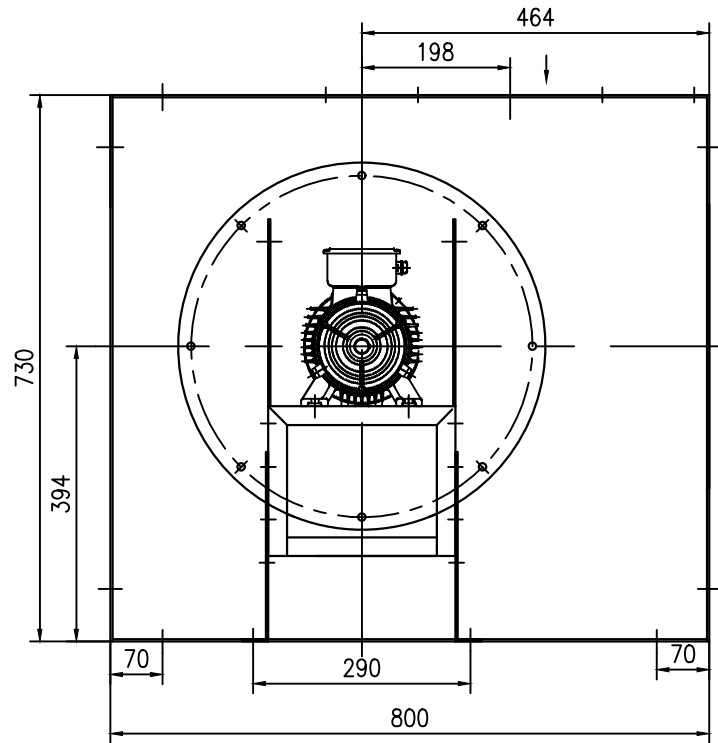

Arama and Benet reserves the right to make changes at any time and without prior notice.

**Total Pressure
(Pa)**

Air Density: 1.2 kg/m³

