

TDF-A-R3 Series Single Inlet Backward Curved Centrifugal Fan



**Arama & Benet**

Air Engineering Solutions

info@arama-benet.com  
www.arama-benet.com

PRODUCT NAME:  
TDF-A-R3 Series Single Inlet  
Backward Curved Centrifugal Fan

PRODUCT TYPE:  
TDFA 355-R3-3.0kW-2

Weight include motor:  
84 kg

Finish: Painted  
Color: RAL 7024

Arama & Benet

www.arama-benet.com

REV 02 04.2024

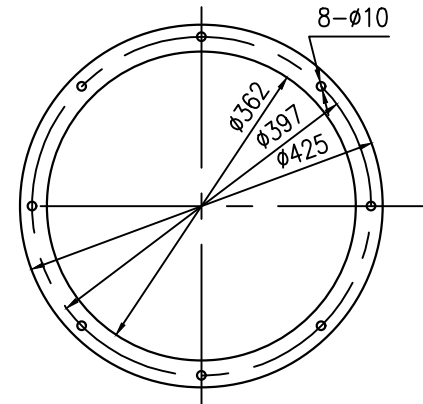
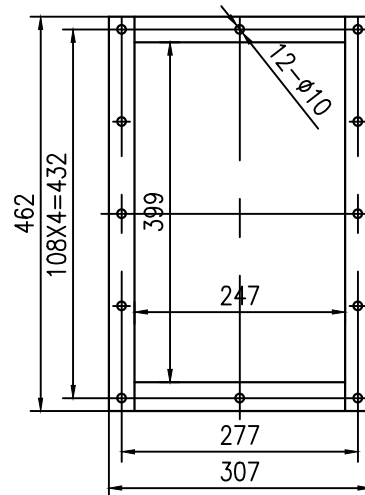
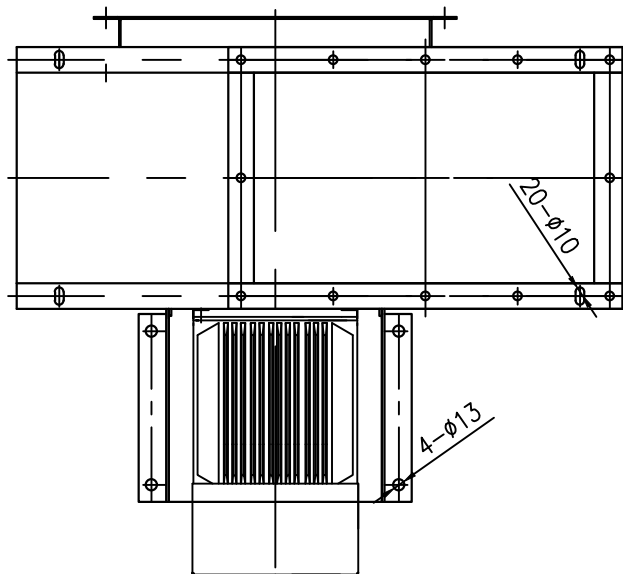
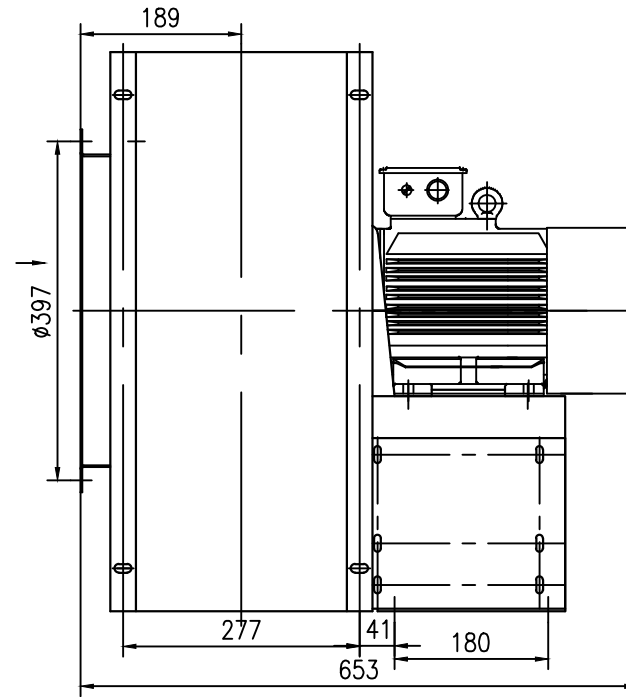
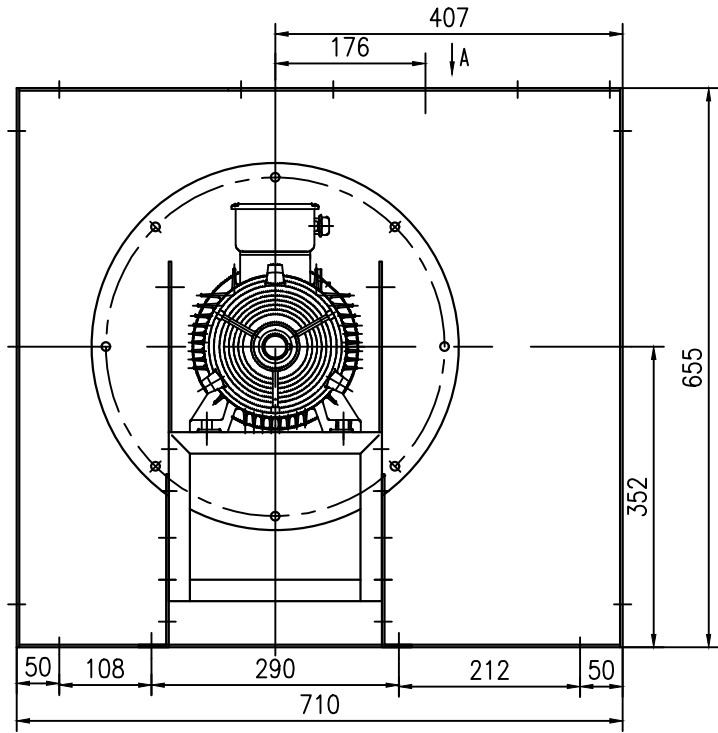

Arama and Benet reserves the right to make changes at any time and without prior notice.

**Total Pressure  
(Pa)**

Air Density: 1.2 kg/m<sup>3</sup>

