

KTF-II Series Centrifugal Fan



Arama & Benet

Air Engineering Solutions

info@arama-benet.com

www.arama-benet.com

PRODUCT NAME:
KTF-II Series Centrifugal Fan

PRODUCT TYPE:
KTF900A-II-22.0kW-4-90°L

Weight include motor:
530 kg

Finish: Painted
Color: RAL 7024

Arama & Benet

www.arama-benet.com

REV.02 06.2024

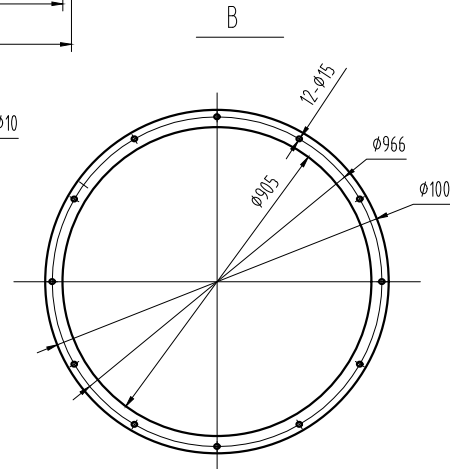
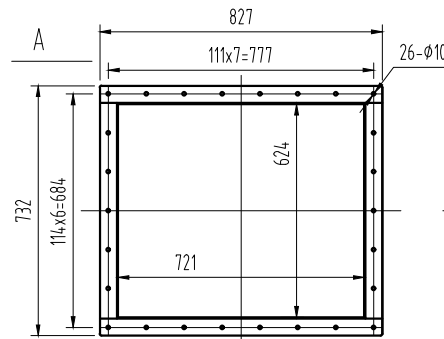
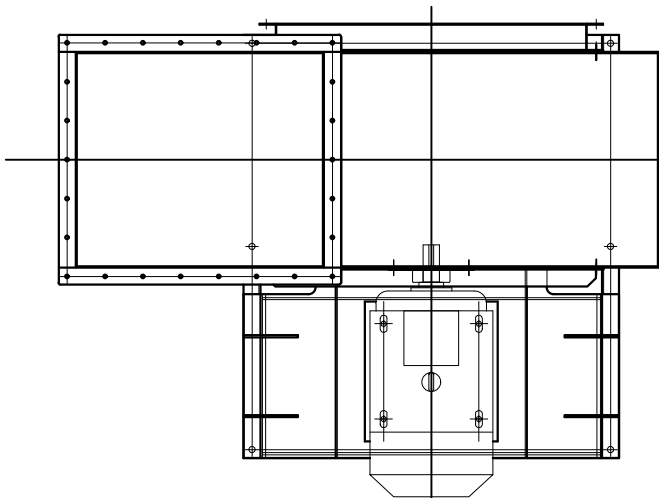
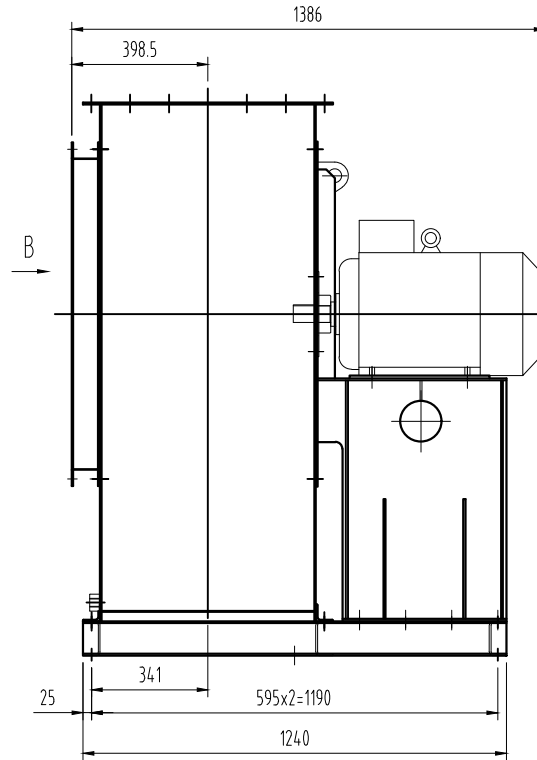
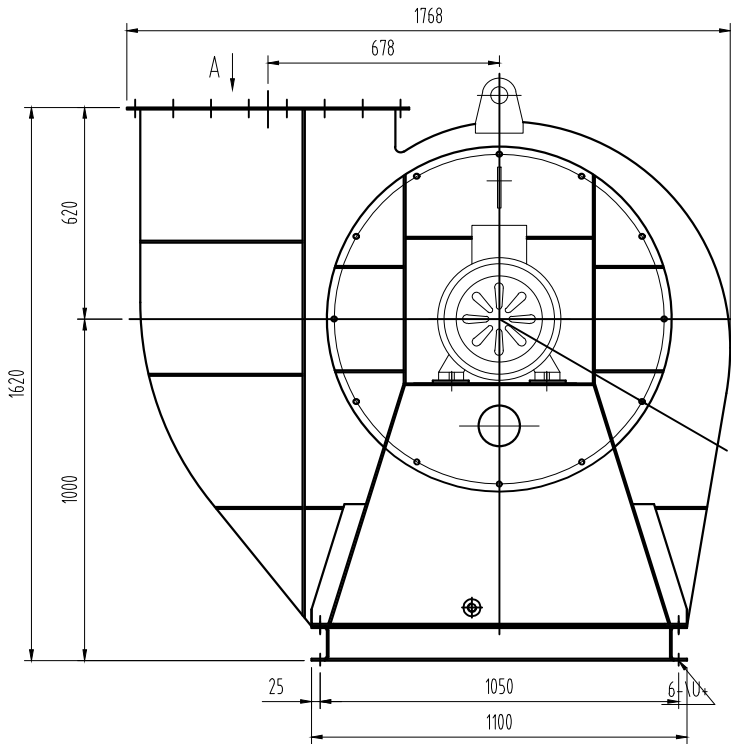

Arama and Benet reserves the right to make changes at any time and without prior notice.